



CNC SWISS TYPE AUTOMATIC LATHE 

# SL-7/10



# High-spec and Compactness A New Generation Machine Specialized in Small Diameter Processing from Star Micronics

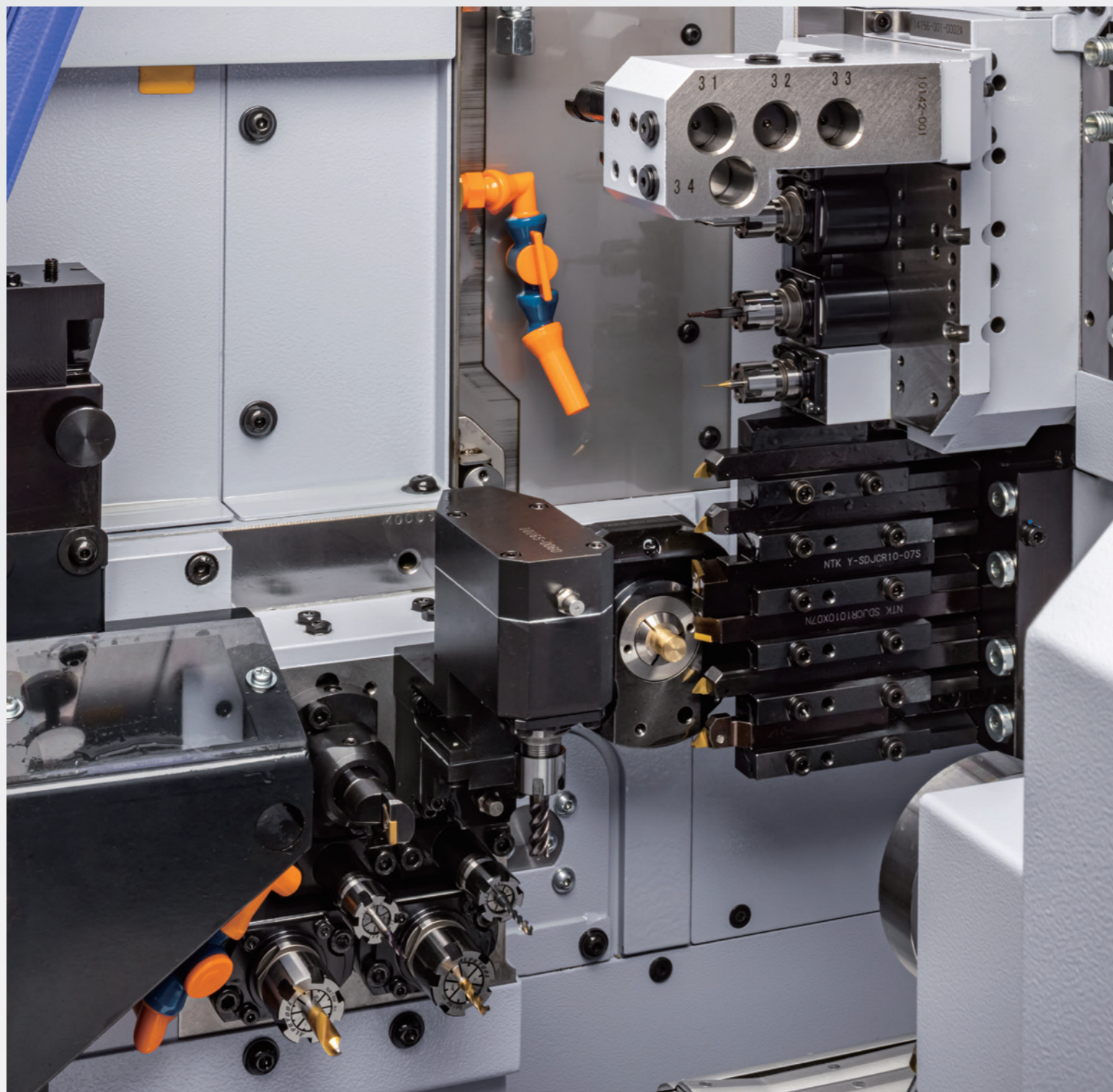

## Condensed high-spec technology fulfilling updated needs by new design idea

State-of-the-art small diameter processing is made possible by yet another evolution of design by Star Micronics. The single gang type tool post is laid out vertically to save space which is a new design concept. The combination of a 5-spindle cartridge-type cross drilling unit and the backworking 6-spindle unit with Y-axis control offers a variety of multi-processing activities. At the same time, the main spindle and faster power-driven tools are designed to optimize small diameter processing. The debut of the SL-7/10 with its compact body and high performance marks the arrival of the new generation of small diameter processing special models for you.

# SL-7/10

## CNC SWISS TYPE AUTOMATIC LATHE

### Machine composition :

- Main spindle
- Sub spindle
- Gang type Tool post
  - Cartridge-type 5-spindle cross drilling unit
- Backworking 6-spindle unit with Y-axis control

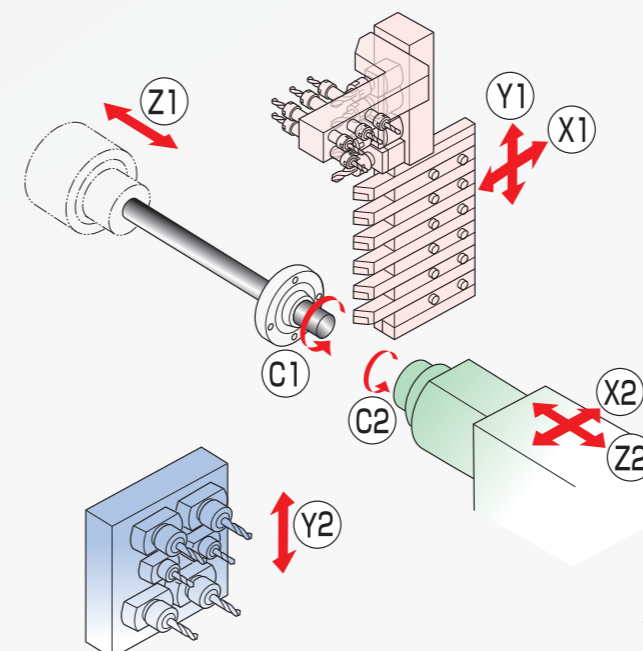

### TOOLING SYSTEM

■ Tool holder	Turning tool	6 tools
■ Sleeve holder (Cartridge Type)	Front-end stationary tool	4 tools or 6 tools
	Rear-end stationary tool	4 tools or 6 tools
■ Power-driven tool	Special tool for cross drilling : 1 tool+ Cartridge type (4pos.)	
■ Backworking 6-spindle unit with Y-axis control	Stationary tool	Max.6 tools
	Power-driven tool	Max.4 tools

# We have optimized small diameter processing through enhanced precision, functionality, and productivity wherever possible.

## In Pursuit of Higher Functionality and Performance

### Main Tool Post with 5-spindle Type Cross Drilling Unit

The main tool post with a 5-spindle type cross drilling unit provides four cartridge positions to mount various tool units for a wide variety of processes.

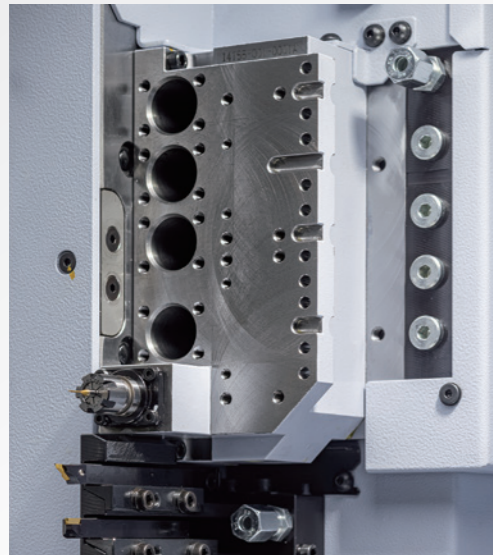

### A Backworking Tool Post that Expands the Range of Multi-Processing Tasks

The tool post is specially designed for a 6-spindle backworking unit with Y-axis control. This expands the variety of backworking processes with mounted power-driven tool units (up to four positions) or coolant-through tools.

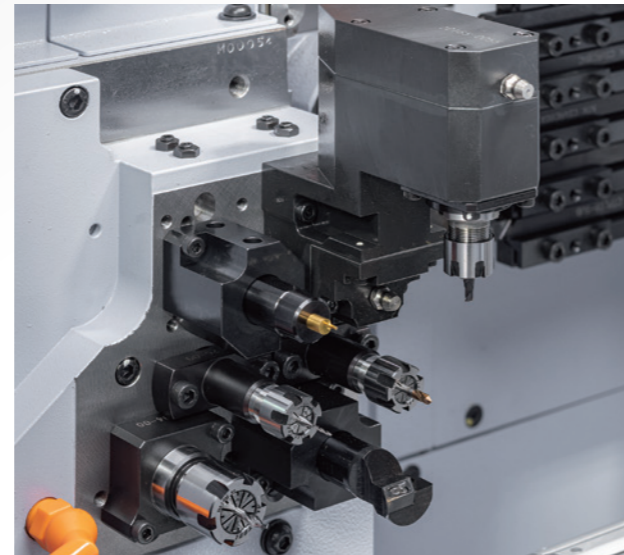

### A Stepcycle Is Equipped as Standard for Effective Chip Breaking

All you have to do is follow the flow chart and set the command coefficient based on the processing conditions (surface speed and feed rate).

#### Chip Breaking

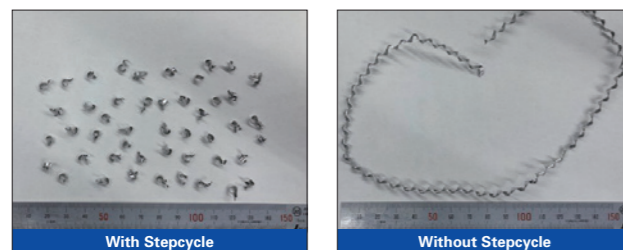

※ For A6061 material for 2.0 mm cutting, surface speed at 100 m/min, and feed rate at 0.03 mm/rev

### A Wider Pitch Between Tools on Backworking Tool Posts

A backworking tool post laid out in three rows of two spindles side by side provides a wider pitch between the tools which reduces the constraints of adjacent tools for more flexible tooling.

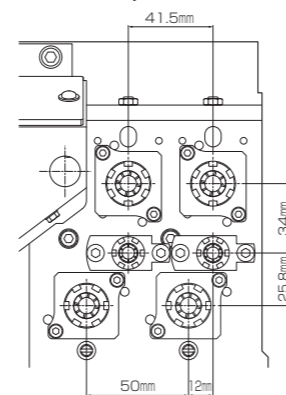

### Motors with Higher Power

High-output motors provide ample power for machining.

Main spindle motor	3.7/5.5kW
Cross machining tool motor	1.0/1.2kW
Backworking tool motor	1.0/1.2kW

### Optimized Spindle Speed for Small Diameter Processing

\* With fixed G.B.

Main spindle	18,000min <sup>-1</sup> *
Sub spindle	12,000min <sup>-1</sup>
Cross machining tool	12,000min <sup>-1</sup>
Backworking tool	12,000min <sup>-1</sup>

## Realization of Higher Rigidity and Precision

### Main and Sub Spindles Designed for High Accuracy Indexing

The main spindle with a built-in motor and the belt-driven sub spindle with a built-in sensor ensure high accuracy indexing.

### Mechanism and Structure to Control Heat

The motor for cross machining is equipped with a cooling fan, and the pedestal is covered with sheet metal to avoid direct contact with coolant to prevent overheating.

### Sensors Correct Thermal Displacement

Sensors in various parts of the machine enable highly accurate and flexible corrections of thermal displacement.

### A Backworking Tool Post with High Rigidity

The tool post for backworking is specially designed to withstand loads and to ensure the rigidity of the backworking 6-spindle unit with Y-axis control.

## Improved Operability and Workability

### Optimally Angled Operation Panel

The 10.4-inch color LCD and the operation panel angled toward the operator improve visibility during operations.



### Flip-up Door

A flip-up door with a large opening in the cutting chamber provides ample workspace.

### Operation and Work Support Software Has Been Expanded

- An automatic backup function enables the restoration of parameters and programs.
- Useful functions to support the setup are provided. The tool unit screen lets you review the tool unit dimensions to be mounted, and the batch program data input/output screen enables the management of various types of data including geometry offset.

#### ① Multi-Path Program Management Screen

You can input, output, copy, and delete programs with the same program number (or name) in a batch on all paths.

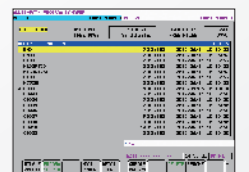

#### ② Batch Program Data Input/Output Screen

Use this screen to input or output the selected program with tool unit data, geometry offset data, and wear offset data in a batch.



#### ③ Tool Unit ID No. Input Screen

The tool unit ID No. can be registered at the tool position number where the tool unit is to be mounted while checking the shape and dimensions of the tool unit.

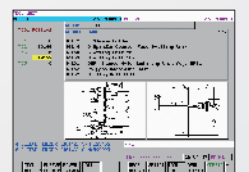

#### ④ Counter Screen

The count, preset values, and cycle time can be reviewed on this screen. The estimated time to reach the count incorporating the time needed to replace materials can also be checked. Inputting the stock length and remnant length calculates the amount of materials required.



### Ejects Workpieces During Stoppages

The ON/OFF switch on the product conveyor allows you to eject a workpiece even when the machine has stopped running.

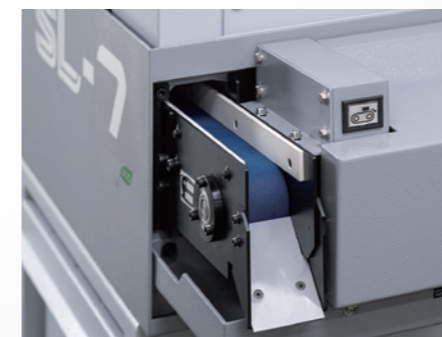

Main Tool Post

TOOLING SYSTEM

Cartridge-type 5-spindle cross drilling unit

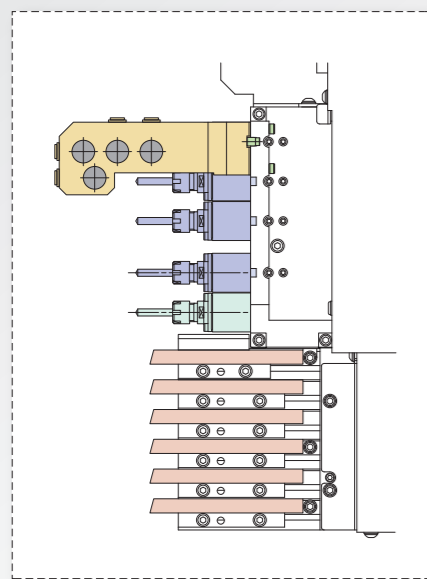

VARIATION 01

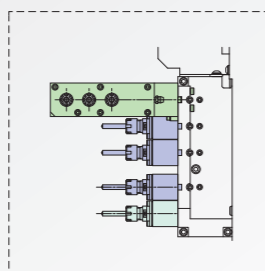

VARIATION 03

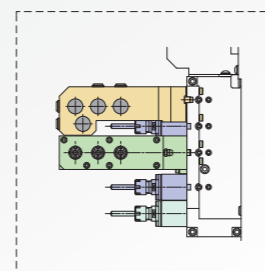

VARIATION 04

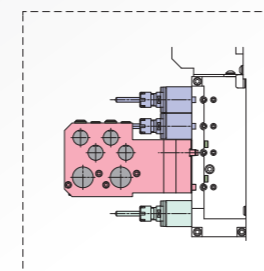

VARIATION 05

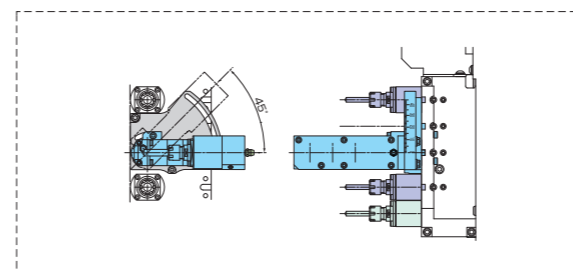

VARIATION 14

- Milling unit
- 4-spindle sleeve holder
- 6-spindle sleeve holder
- 3-spindle counterface drilling unit
- Skewed hole processing unit
- Slotting unit
- Thread whirling unit
- Polygon machining unit
- Gear hobbing unit

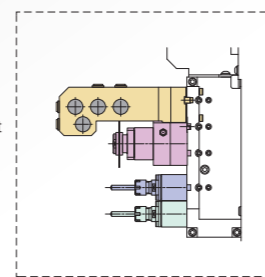

VARIATION 06

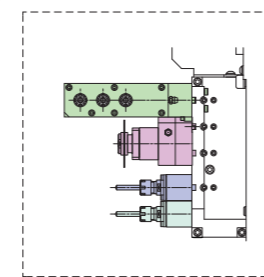

VARIATION 07

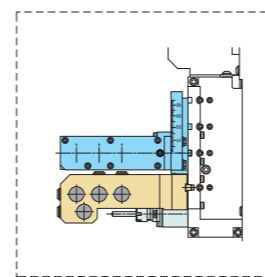

VARIATION 15

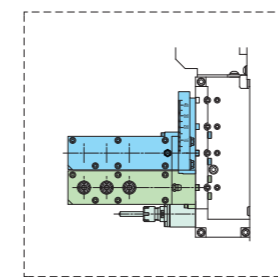

VARIATION 16

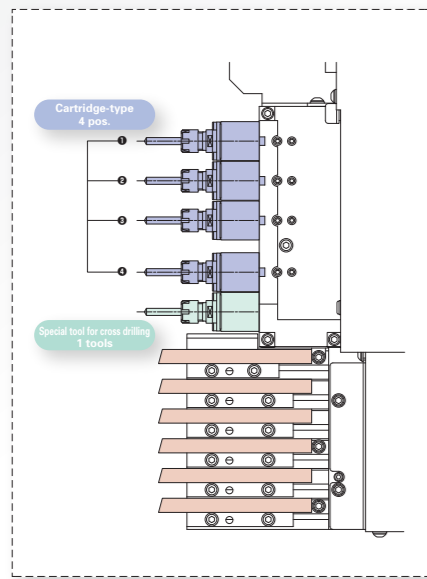

VARIATION 02

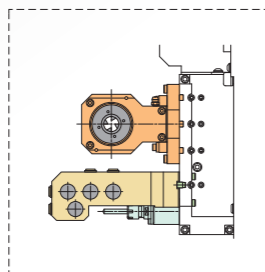

VARIATION 08

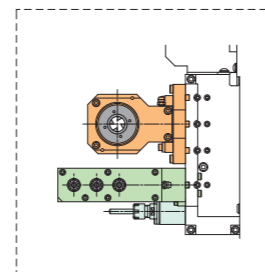

VARIATION 09

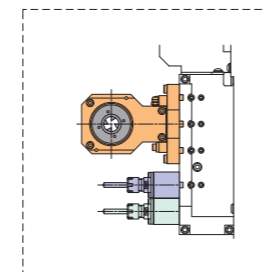

VARIATION 10

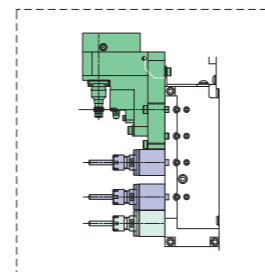

VARIATION 17

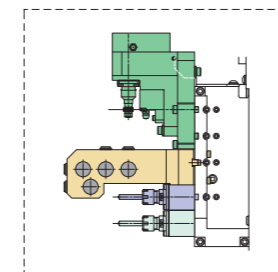

VARIATION 18

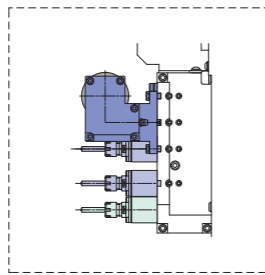

VARIATION 11

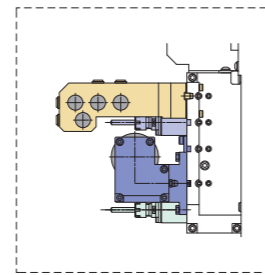

VARIATION 12

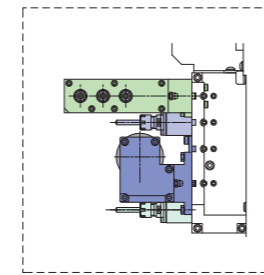

VARIATION 13

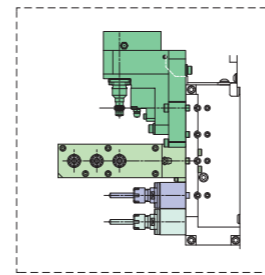

VARIATION 19

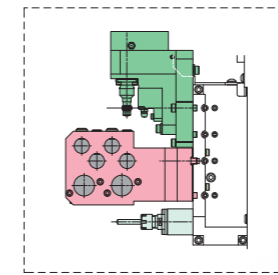

VARIATION 20

Backworking Tool Post

TOOLING SYSTEM

Backworking 6-spindle unit with Y-axis control

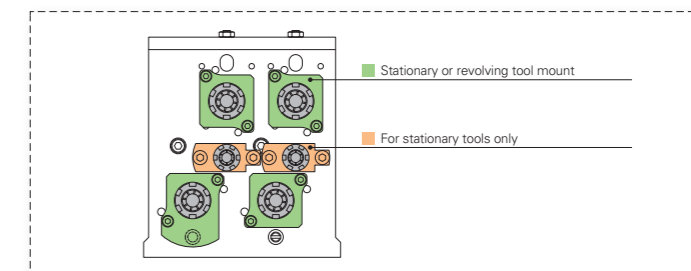

VARIATION 01

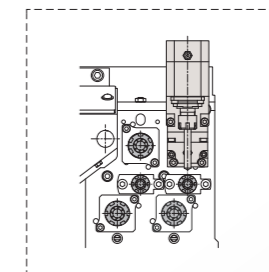
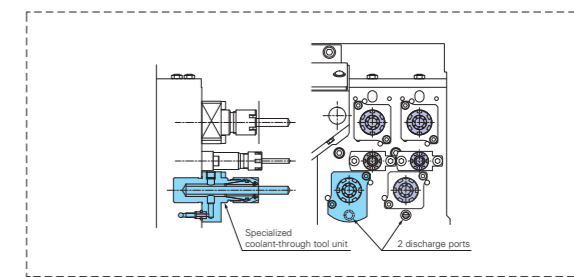

VARIATION 02

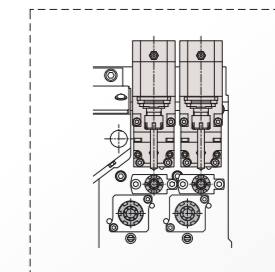

VARIATION 03

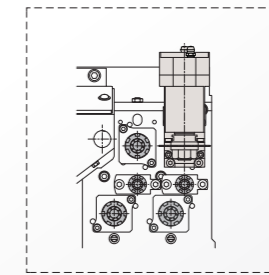

VARIATION 04

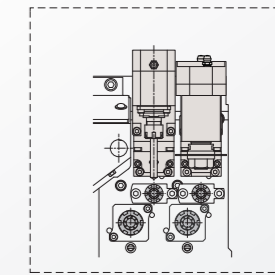

VARIATION 05

Main Tool Post

Tool Units



■ Milling unit



■ 4-spindle sleeve holder

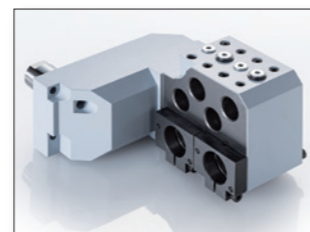

■ 6-spindle sleeve holder

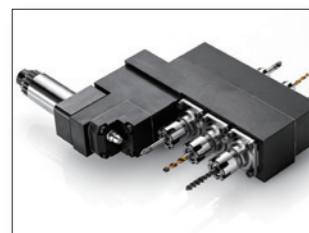

■ 3-spindle counterface drilling unit

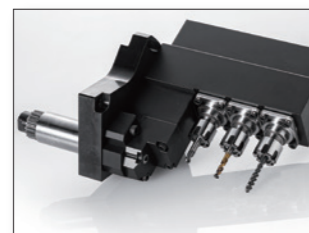

■ Skewed hole processing unit

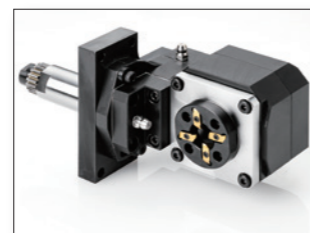

■ Thread whirling unit



■ Slotting unit

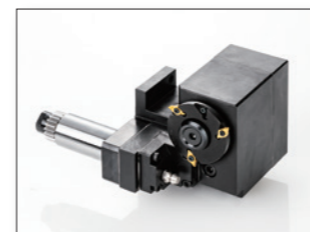

■ Polygon machining unit



■ Gear hobbing unit

Backworking Tool Post

Tool Units

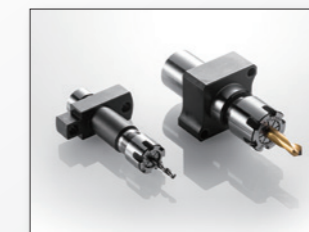

■ Drill sleeve



■ Specialized coolant-through tool unit



■ Cross drilling unit



■ Slotting unit

## □ Standard Machine Specifications

Item	Specifications	
Max. machining diameter	φ 10mm(25/64in)	
Max. headstock stroke	Stationary G.B. type	135mm(5-5/16in)
	R.G.B. type	105mm(4-9/64in)
	R.M.G.B. type	75mm(2-61/64in)
Tool	Number of tools	6 tools
	Tool shank	□8mm / □10mm
Sleeve holder	4-spindle	φ 16mm(5/8in)×4 tools
	6-spindle	φ 16mm(5/8in)×4 tools φ 22mm(55/64in)×2 tools
	Max. drilling capability	φ 6mm(15/64in)
Power driven attachment	Max. tapping capability	M5×P0.8
	Number of tools	Cross milling 1 tools(ER11) + Cartridge type 4 positions
	Max. drilling capability	φ 5mm(3/16in)
	Max. tapping capability	M4×P0.7
	Spindle speed	Max. 12,000min <sup>-1</sup>
Rapid feed rate	1.0kW(continuous) / 1.2kW(5min./30%ED)	
Main spindle indexing angle	35m/min (X1, X2, Y1, Z1, Z2), 15m/min (Y2)	
Main spindle speed	C-axis control	
	Stationary G.B. type	Max. 18,000min <sup>-1</sup>
Main spindle motor	R.G.B. type	Max. 15,000min <sup>-1</sup>
		3.7kW(continuous) / 5.5kW(10min./25%ED)
Coolant tank capacity	109 ℓ	
Dimensions (W×D×H)	1,865×795×1,815mm	
Weight	1,600kg	
Power consumption	3.8kVA	
A-weighted sound pressure : note-1	Max. 74dB(A)	

## □ Backworking Attachment Specifications

Item	Specifications		
Max. chucking diameter	φ 10mm(25/64in)		
Max. length for front ejection	70mm(2-3/4in)		
Max. parts projection length	20mm(25/32in)		
Back 6-spindle unit	Number of tools	6 tools	
	Max. drilling capability	Stationary tool	φ 6mm(15/64in)
		Power driven tool	φ 5mm(3/16in)
	Max. tapping capability	Stationary tool	M5×P0.8
		Power driven tool	M4×P0.7
	Power-driven att. spindle speed	Max. 12,000min <sup>-1</sup>	
Power-driven att. drive motor	1.0kW(continuous) / 1.2kW(5min./30%ED)		
Sub spindle indexing angle	C-axis control		
Sub spindle speed	Max. 12,000min <sup>-1</sup>		
Sub spindle motor	0.55kW(continuous) / 1.1kW(15min./40%ED)		

\* The specification value depending on the type of sub-spindle chuck. Please confirm the details with the sales manager.

## □ External Dimensions and Floor Space

unit : mm(ft)

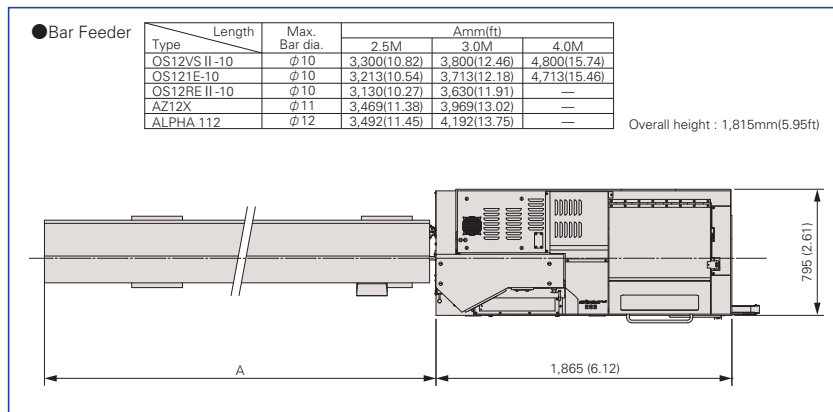

## □ Standard Accessories and Functions

1. CNC unit FANUC 32i-B
2. Operation panel 10.4-inch color LCD display
3. Pneumatic unit
4. Coolant level detector
5. Automatic centralized lubrication unit
6. Door interlock system
7. Cs contouring control (Main / Sub)
8. Spindle clamp unit (Main / Sub)
9. Revolving guide bush unit
10. Drive unit for revolving guide bush
11. Air purge for revolving guide bush
12. Main / Sub collet
13. 6-station tool holder (□8 mm or □10 mm)
14. 4-spindle sleeve holder
15. 5-spindle cross drilling unit
16. Broken cutoff tool detector
17. Backworking attachment
18. Back 6-spindle unit
19. Drive unit for power-driven (6-spindle backworking unit)
20. Sub spindle air purge unit
21. Sub spindle air blow unit
22. Parts ejection detector
23. Work light
24. Leakage breaker

## □ Optional Accessories and Functions

1. Manual pulse generator
2. Coolant flow detector
3. Check valve
4. Parts conveyor
5. Parts receptacle in Machine
6. Oil pan cover
7. Water separator
8. Oil mist filter
9. Beacon
10. Main spindle inner tube
11. Rotary magic guide bush unit
12. Parts ejector (Spring type)
13. Parts ejector (Air cylinder type)
14. Parts ejector with guide tube
15. Product separator system, A-type
16. Coolant unit (2.5MPa/0.7MPa)
17. Coolant unit signal cable
18. Coolant unit power cable
19. Coolant valve
20. Coolant pipings
21. Coolant pump with defoaming function
22. 400 W coolant pump
23. Automatic bar feeder interface
24. LAN/RS232C interface
25. Chip conveyor interface
26. Transformer
27. Transformer CE marking version
28. CE/UKCA marking

Note)

The machining capacities apply to SUS303 material. The machining capacities may differ from listed values depending on the machining conditions, such as the material to be machined or the tools to be used.

- note-1 : ● Measures conforming to ISO standard.  
● A-weighted sound pressure is a general assessment standard characteristic that corrected the sound level to human acoustic sense.

※Design features, specifications and technical execution are subject to change without prior notice.

※This product is an export control item subject to the foreign exchange and foreign trade laws. Thus, before exporting this product, or taking it overseas, contact your STAR MICRONICS dealer.

# STAR MICRONICS CO., LTD.

## Machine Tools Division

1500-34 Kitanoya, Misawa, Kikugawa, Shizuoka, 439-0023 Japan  
TEL.+81-537-36-5594 FAX.+81-537-36-5607

<http://www.star-m.jp/eng/>

**Star CNC Machine Tool Corporation**  
123 Powerhouse Road, Roslyn Heights, NY 11577, U.S.A.  
TEL.+1-516-484-0500 FAX.+1-516-484-5820

**Star Micronics GB Limited**  
Unit 1 Riverlands Business Park Raynesway DERBY DE21 7BZ  
TEL.+44-1332-86-44-55 FAX.+44-1332-86-40-05

**Star Micronics GmbH**  
Robert-Grob-Str. 1, D-75305 Neuenburg, Germany  
TEL.+49-7082-7920-0 FAX.+49-7082-7920-20

**Star Micronics AG**  
Luelstrasse 3, CH-8112 Otelfingen, Switzerland  
TEL.+41-43-411-80-60 FAX.+41-43-411-60-66

**Star Machine Tool France**  
90 Allée de Glaisy, ZI 74300 Thyez Haute Savoie, France  
TEL.+33-450-96-05-97 FAX.+33-450-96-91-54

**Shanghai Xingang Machinery Co., Ltd.**  
2F, 229 Fute Rd. N. The China (Shanghai) Pilot Free Trade Zone  
TEL.+86-21-5868-2100 FAX.+86-21-5868-2101

**Star Micronics (Thailand) Co., Ltd.**  
289/23 M.13 Soi Kingkaew 25/1, Kingkaew Rd., T.Rachathewa A.Bangplee Samutprakarn 10540, Thailand  
TEL.+66-2-186-8945-47 FAX.+66-2-183-7845

**9001 | ISO 14001**  
CERTIFIED

2021.09\_Ver1.0\_1